

**Full - Bridge
NPT & Trench + Field Stop[®] IGBT
Power module**

Trench & Field Stop[®] IGBT Q1, Q3:
 $V_{CES} = 600V$; $I_C = 30A$ @ $T_c = 80^\circ C$

Fast NPT IGBT Q2, Q4:
 $V_{CES} = 600V$; $I_C = 30A$ @ $T_c = 80^\circ C$

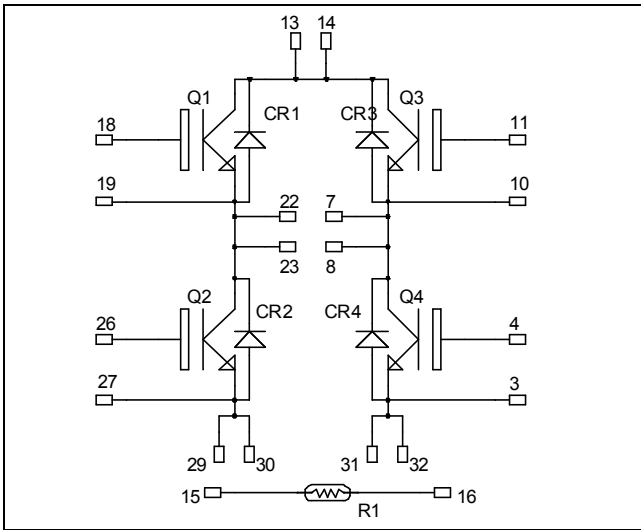

Top switches : Trench + Field Stop IGBT[®]
 Bottom switches : FAST NPT IGBT

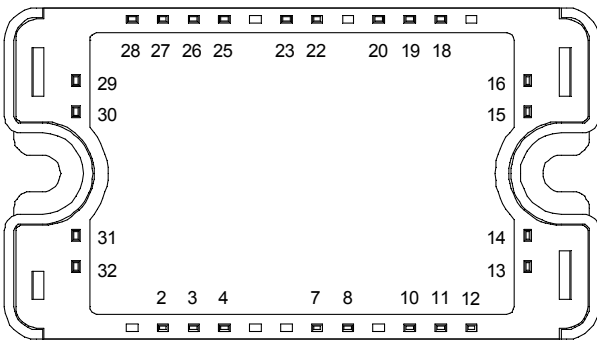

All multiple inputs and outputs must be shorted together
 13/14 ; 15/16 ; 26/27 ; 31/32

Application

- Solar converter

Features

- **Q2, Q4 FAST Non Punch Through (NPT) IGBT**
 - Switching frequency up to 100 kHz
 - RBSOA & SCSOA rated
 - Low tail current
- **Q1, Q3 Trench & Field Stop IGBT[®]**
 - Low voltage drop
 - Switching frequency up to 20 kHz
 - RBSOA & SCSOA rated
 - Low tail current

- Kelvin emitter for easy drive
- Very low stray inductance
- High level of integration
- Internal thermistor for temperature monitoring

Benefits

- Optimized conduction & switching losses
- Direct mounting to heatsink (isolated package)
- Low junction to case thermal resistance
- Solderable terminals both for power and signal for easy PCB mounting
- Low profile
- Easy paralleling due to positive T_C of V_{CEsat}
- RoHS Compliant

CAUTION: These Devices are sensitive to Electrostatic Discharge. Proper Handling Procedures Should Be Followed. See application note APT0502 on www.microsemi.com

All ratings @ $T_j = 25^\circ\text{C}$ unless otherwise specified

1. Top switches

1.1 Top Trench + Field Stop IGBT[®] characteristics

Absolute maximum ratings

Symbol	Parameter	Max ratings	Unit
V_{CES}	Collector - Emitter Breakdown Voltage	600	V
I_C	Continuous Collector Current	$T_C = 25^\circ\text{C}$	50
		$T_C = 80^\circ\text{C}$	30
I_{CM}	Pulsed Collector Current	$T_C = 25^\circ\text{C}$	60
V_{GE}	Gate - Emitter Voltage	± 20	V
P_D	Maximum Power Dissipation	$T_C = 25^\circ\text{C}$	90
RBSOA	Reverse Bias Safe Operating Area	$T_j = 150^\circ\text{C}$	60A @ 550V

Electrical Characteristics

Symbol	Characteristic	Test Conditions	Min	Typ	Max	Unit
I_{CES}	Zero Gate Voltage Collector Current	$V_{GE} = 0\text{V}, V_{CE} = 600\text{V}$			250	μA
$V_{CE(sat)}$	Collector Emitter Saturation Voltage	$V_{GE} = 15\text{V}$ $I_C = 30\text{A}$	$T_j = 25^\circ\text{C}$	1.5	1.9	V
			$T_j = 150^\circ\text{C}$	1.7		
$V_{GE(th)}$	Gate Threshold Voltage	$V_{GE} = V_{CE}, I_C = 400\mu\text{A}$	5.0	5.8	6.5	V
I_{GES}	Gate - Emitter Leakage Current	$V_{GE} = 20\text{V}, V_{CE} = 0\text{V}$			300	nA

Dynamic Characteristics

Symbol	Characteristic	Test Conditions	Min	Typ	Max	Unit
C_{ies}	Input Capacitance	$V_{GE} = 0\text{V}$ $V_{CE} = 25\text{V}$ $f = 1\text{MHz}$		1600		pF
C_{oes}	Output Capacitance			110		
C_{res}	Reverse Transfer Capacitance			50		
$T_{d(on)}$	Turn-on Delay Time	Inductive Switching (25°C) $V_{GE} = \pm 15\text{V}$ $V_{Bus} = 300\text{V}$ $I_C = 30\text{A}$ $R_G = 10\Omega$		110		ns
T_r	Rise Time			45		
$T_{d(off)}$	Turn-off Delay Time			200		
T_f	Fall Time			40		
$T_{d(on)}$	Turn-on Delay Time	Inductive Switching (150°C) $V_{GE} = \pm 15\text{V}$ $V_{Bus} = 300\text{V}$ $I_C = 30\text{A}$ $R_G = 10\Omega$		120		ns
T_r	Rise Time			50		
$T_{d(off)}$	Turn-off Delay Time			250		
T_f	Fall Time			60		
E_{on}	Turn-on Switching Energy	$V_{GE} = \pm 15\text{V}$ $V_{Bus} = 300\text{V}$ $I_C = 30\text{A}$ $R_G = 10\Omega$	$T_j = 25^\circ\text{C}$	0.16		mJ
			$T_j = 150^\circ\text{C}$	0.3		
E_{off}	Turn-off Switching Energy	$I_C = 30\text{A}$ $R_G = 10\Omega$	$T_j = 25^\circ\text{C}$	0.7		mJ
			$T_j = 150^\circ\text{C}$	1.05		
R_{thJC}	Junction to Case Thermal resistance				1.6	$^\circ\text{C}/\text{W}$

1.2 Top fast diode characteristics

<i>Symbol</i>	<i>Characteristic</i>	<i>Test Conditions</i>		<i>Min</i>	<i>Typ</i>	<i>Max</i>	<i>Unit</i>
V _{RRM}	Maximum Peak Repetitive Reverse Voltage			600			V
I _{RM}	Maximum Reverse Leakage Current	V _R =600V	T _j = 25°C			25	μA
			T _j = 125°C			500	
I _F	DC Forward Current	T _c = 80°C			25		A
V _F	Diode Forward Voltage	I _F = 25A			1.8	2.2	V
		I _F = 50A			2.2		
		I _F = 25A	T _j = 125°C		1.6		
t _{rr}	Reverse Recovery Time	I _F = 25A V _R = 400V di/dt = 200A/μs	T _j = 25°C		30		ns
			T _j = 125°C		175		
Q _{rr}	Reverse Recovery Charge	I _F = 25A V _R = 400V di/dt = 200A/μs	T _j = 25°C		55		nC
			T _j = 125°C		485		
R _{thJC}	Junction to Case Thermal resistance					1.4	°C/W

2. Bottom switches

2.1 Bottom Fast NPT IGBT characteristics

Absolute maximum ratings

<i>Symbol</i>	<i>Parameter</i>	<i>Max ratings</i>		<i>Unit</i>
V _{CES}	Collector - Emitter Breakdown Voltage	600		V
I _C	Continuous Collector Current	T _C = 25°C	42	A
		T _C = 80°C	30	
I _{CM}	Pulsed Collector Current	T _C = 25°C	100	
V _{GE}	Gate - Emitter Voltage	±20		V
P _D	Maximum Power Dissipation	T _C = 25°C	140	W
RBSOA	Reverse Bias Safe Operating Area	T _j = 125°C	60A@500V	

Electrical Characteristics

<i>Symbol</i>	<i>Characteristic</i>	<i>Test Conditions</i>		<i>Min</i>	<i>Typ</i>	<i>Max</i>	<i>Unit</i>
I _{CES}	Zero Gate Voltage Collector Current	V _{GE} = 0V V _{CE} = 600V	T _j = 25°C			250	μA
			T _j = 125°C			500	
V _{CE(sat)}	Collector Emitter saturation Voltage	V _{GE} = 15V I _C = 30A	T _j = 25°C	1.7	2.0	2.45	V
			T _j = 125°C		2.2		
V _{GE(th)}	Gate Threshold Voltage	V _{GE} = V _{CE} , I _C = 1mA		4		6	V
I _{GES}	Gate - Emitter Leakage Current	V _{GE} = 20V, V _{CE} = 0V				400	nA

Dynamic Characteristics

Symbol	Characteristic	Test Conditions	Min	Typ	Max	Unit
C _{ies}	Input Capacitance	V _{GE} = 0V		1350		pF
C _{oes}	Output Capacitance	V _{CE} = 25V		193		
C _{res}	Reverse Transfer Capacitance	f = 1MHz		120		
Q _g	Total gate Charge	V _{GE} = 15V		99		nC
Q _{ge}	Gate – Emitter Charge	V _{Bus} = 300V		10		
Q _{gc}	Gate – Collector Charge	I _C = 30A		60		
T _{d(on)}	Turn-on Delay Time	Inductive Switching (25°C)		30		ns
T _r	Rise Time	V _{GE} = 15V		12		
T _{d(off)}	Turn-off Delay Time	V _{Bus} = 400V		80		
T _f	Fall Time	I _C = 30A R _G = 6.8Ω		15		
T _{d(on)}	Turn-on Delay Time	Inductive Switching (125°C)		32		ns
T _r	Rise Time	V _{GE} = 15V		12		
T _{d(off)}	Turn-off Delay Time	V _{Bus} = 400V		90		
T _f	Fall Time	I _C = 30A R _G = 6.8Ω		21		
E _{on}	Turn-on Switching Energy	V _{GE} = 15V V _{Bus} = 400V	T _j = 125°C	0.3		mJ
E _{off}	Turn-off Switching Energy	I _C = 30A R _G = 6.8Ω	T _j = 125°C	0.8		
R _{thJC}	Junction to Case Thermal resistance				0.9	°C/W

2.2 Bottom diode characteristics

Symbol	Characteristic	Test Conditions	Min	Typ	Max	Unit
V _{RRM}	Maximum Peak Repetitive Reverse Voltage		600			V
I _{RM}	Maximum Reverse Leakage Current	V _R = 600V			150	μA
					500	
I _F	DC Forward Current			15		A
V _F	Diode Forward Voltage	I _F = 15A		1.6	1.8	V
		I _F = 30A		1.9		
		I _F = 15A	T _j = 125°C	1.4		
t _{rr}	Reverse Recovery Time	I _F = 15A V _R = 400V	T _j = 25°C	40		ns
			T _j = 125°C	150		
Q _{rr}	Reverse Recovery Charge	di/dt = 200A/μs	T _j = 25°C	95		nC
			T _j = 125°C	520		
R _{thJC}	Junction to Case Thermal resistance				2.0	°C/W

3. Temperature sensor

NTC (see application note APT0406 on www.microsemi.com for more information).

Symbol	Characteristic	Min	Typ	Max	Unit
R ₂₅	Resistance @ 25°C		50		kΩ
B _{25/85}	T ₂₅ = 298.15 K		3952		K

$$R_T = \frac{R_{25}}{\exp\left[B_{25/85}\left(\frac{1}{T_{25}} - \frac{1}{T}\right)\right]}$$

T: Thermistor temperature
 R_T: Thermistor value at T

4. Package characteristics

Symbol	Characteristic	Min	Typ	Max	Unit	
V _{ISOL}	RMS Isolation Voltage, any terminal to case t=1 min, I _{isol} <1mA, 50/60Hz	2500			V	
T _J	Operating junction temperature range	-40		150*	°C	
T _{STG}	Storage Temperature Range	-40		125		
T _C	Operating Case Temperature	-40		100		
Torque	Mounting torque	To heatsink	M4	2.5	4.7	N.m
Wt	Package Weight				110	g

T_j=175°C for Trench & Field Stop IGBT

5. SP3 Package outline (dimensions in mm)

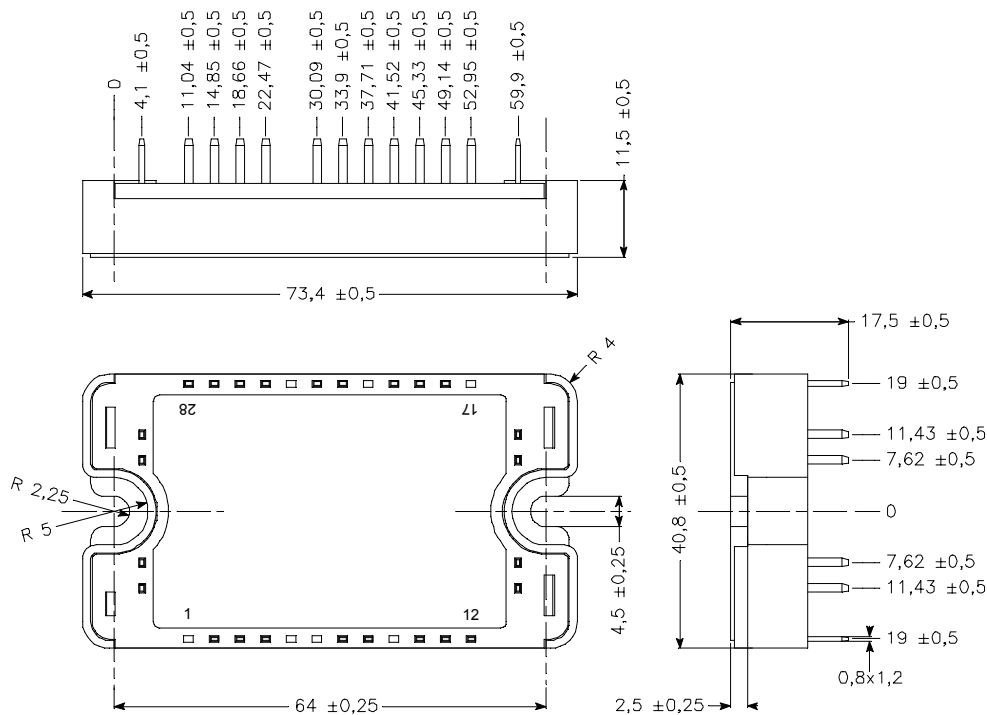

See application note 1901 - Mounting Instructions for SP3 Power Modules on www.microsemi.com

6. Top switches curves

6.1 Top Trench + Field Stop IGBT® typical performance curves

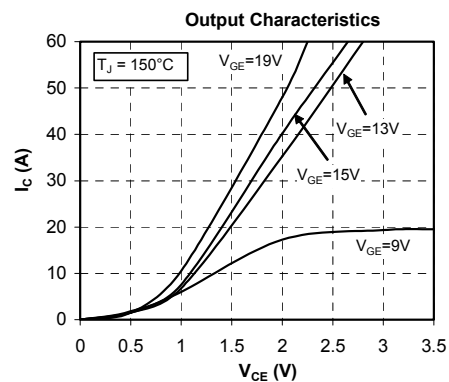
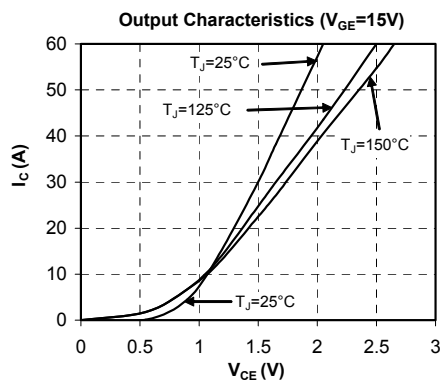

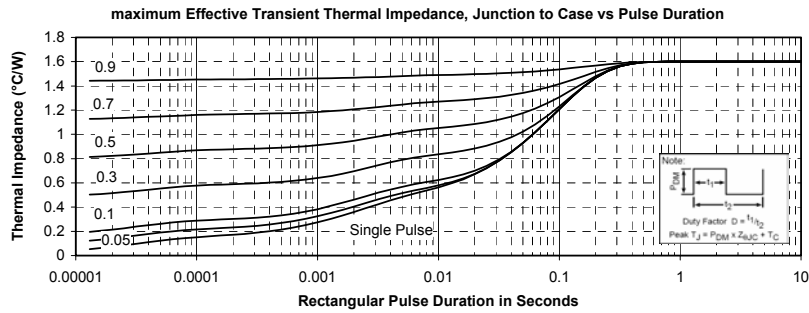
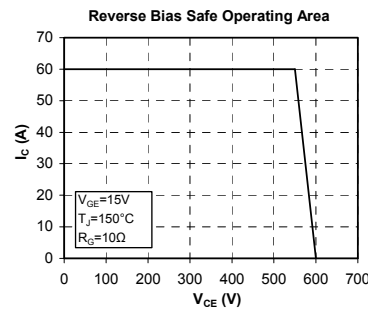
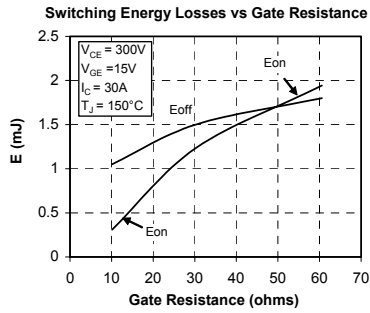
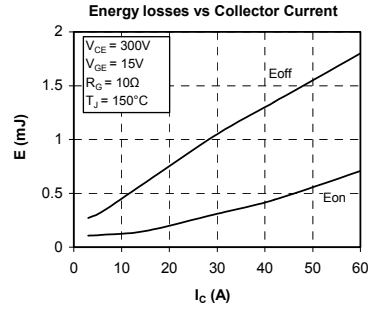
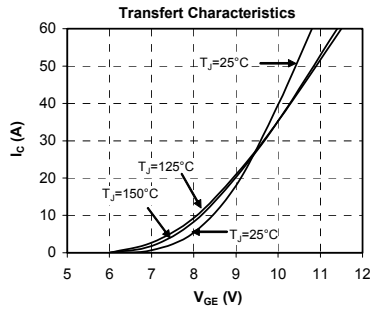

6.2 Top Fast diode typical performance curves

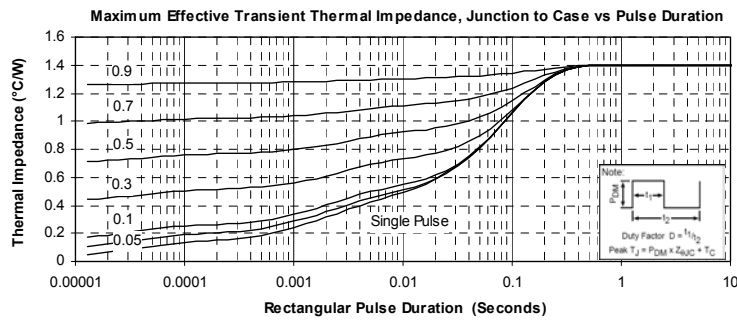
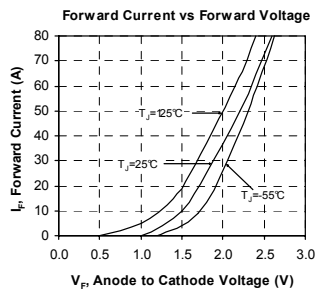

7. Bottom switches curves

7.1 Bottom fast NPT IGBT typical performance curves

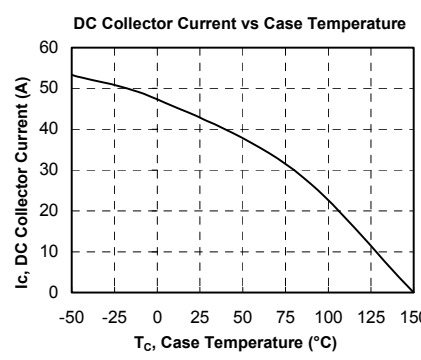
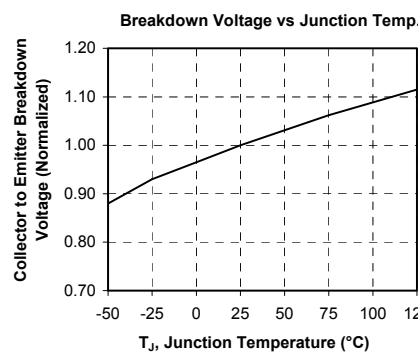
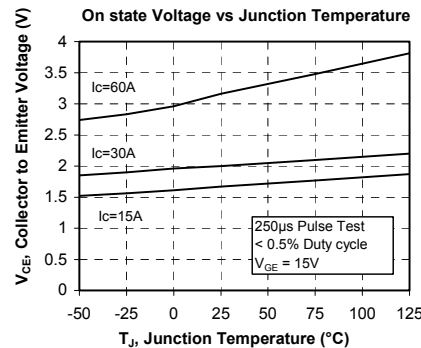
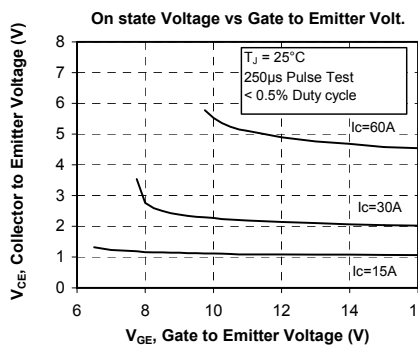
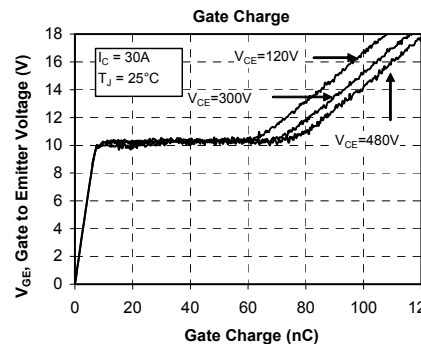
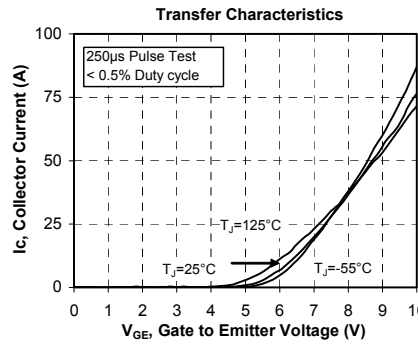
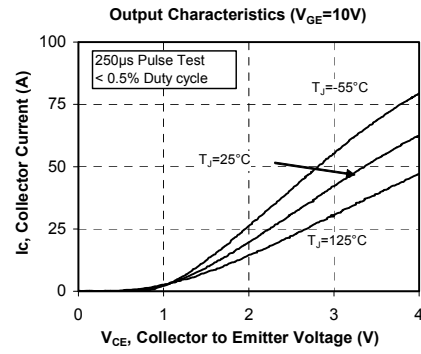
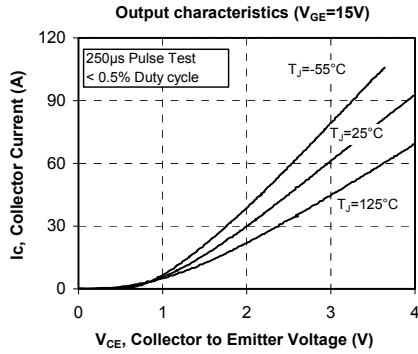

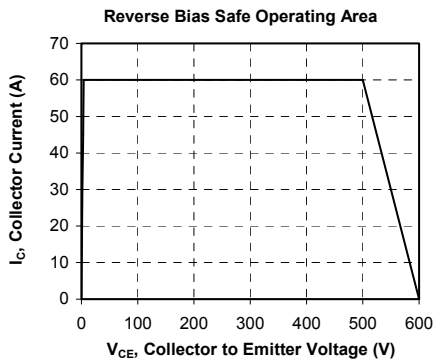
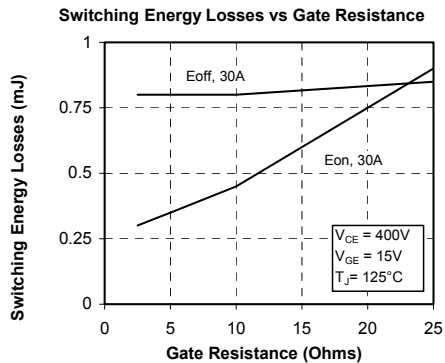
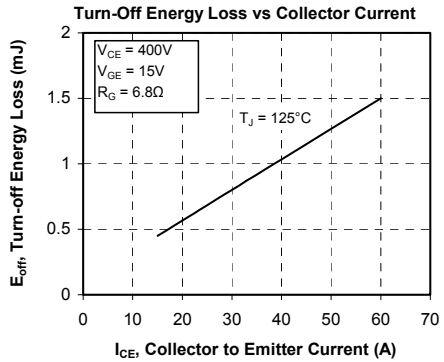
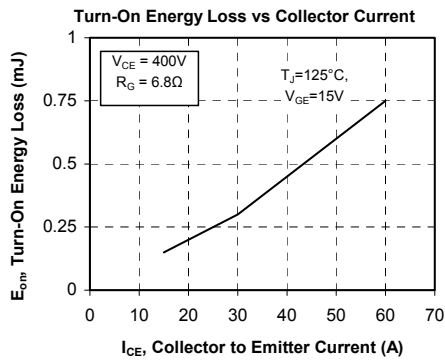
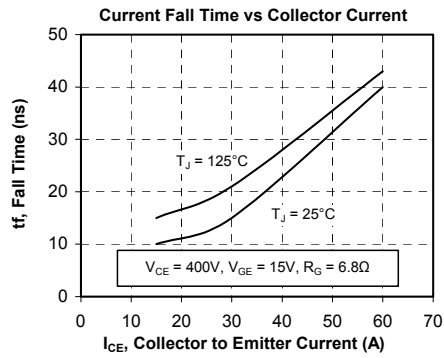
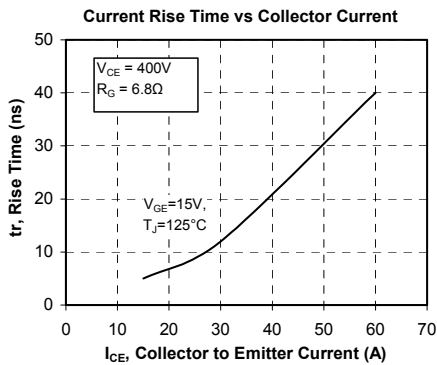
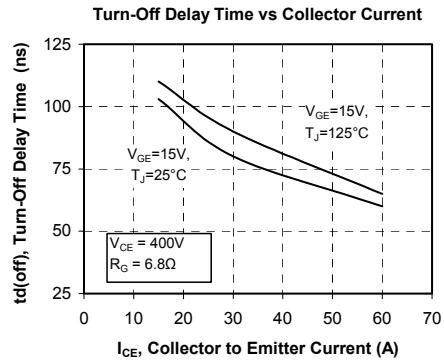
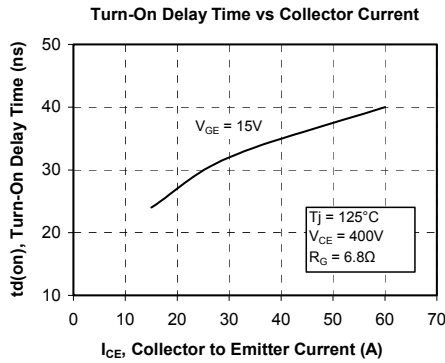

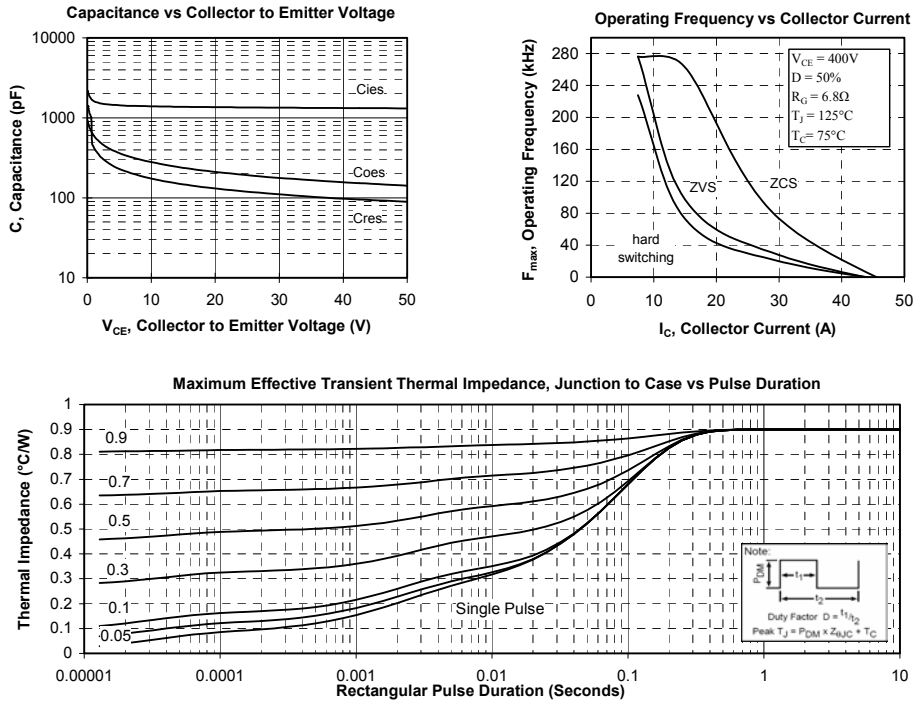

7.2 Bottom diode typical performance curves

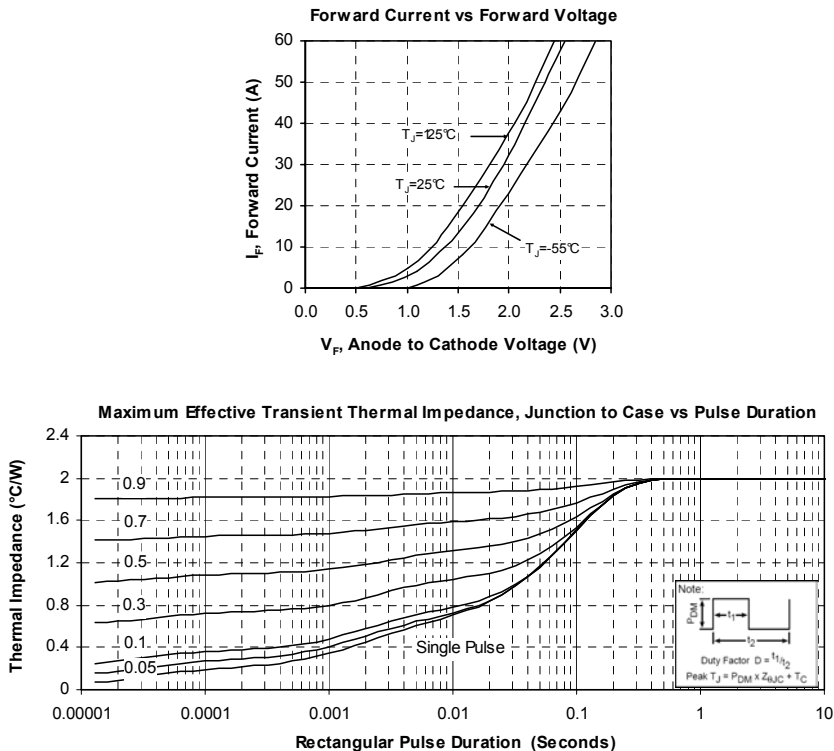

Microsemi reserves the right to change, without notice, the specifications and information contained herein

Microsemi's products are covered by one or more of U.S. patents 4,895,810 5,045,903 5,089,434 5,182,234 5,019,522 5,262,336 6,503,786 5,256,583 4,748,103 5,283,202 5,231,474 5,434,095 5,528,058 and foreign patents. U.S. and Foreign patents pending. All Rights Reserved.